

GXO-E31J

2.5V LV-PECL Oscillator for High Speed Data Transfer

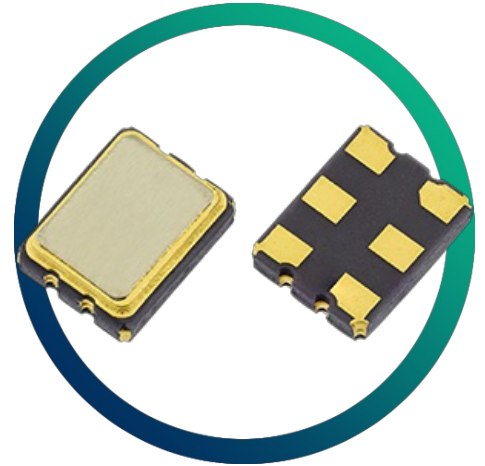

- Complementary LV-PECL output
- RMS phase jitter 0.3ps
- Multiplier-free design
- Enable / disable tristate function
- Designed for high speed data transfer

CONFIGURABLE OPTIONS

Parameter	Option Code
Frequency	
Frequency stability*	
* see note below	
Any	
±100ppm	
±50ppm	B
±25ppm (<160MHz)	A
Operating temperature range	
Any	
-10 to +70 °C	
-40 to +85 °C	I

* Frequency stability is inclusive of calibration @ 25 °C, operating temperature range, supply voltage change and load change.

SPECIFICATIONS

Frequency range	40.0 ~ 60.0MHz (fundamental) 60.0 ~ 160MHz (3rd OT) 160.0 ~ 250MHz (inverted mesa)
Dimensions	3.2 x 2.5 x 1.1mm
Storage temperature range	-40 to +85°C
Supply voltage (V _{DD})	+2.5V (±5%)
Supply current	45mA max (40.0~160MHz) 50mA max (>160~250MHz)
Output	Complementary LV-PECL
Test load	R _T = 50Ω V _{TT} = V _{DD} -2.0V
Logic levels	'0' level = V _{DD} -1.81 ~ V _{DD} -1.62 '1' level = V _{DD} -1.025 ~ V _{DD} -0.88
Waveform symmetry	45:55 max @ 50%V _{P-P}
Rise / fall time	0.4ns max (20 ~ 80%V _{P-P})
Enable / disable function	Tristate (control via pad 1)
Phase jitter RMS	1ps max (0.3ps typ), 12kHz~20MHz

PACKAGE DRAWING

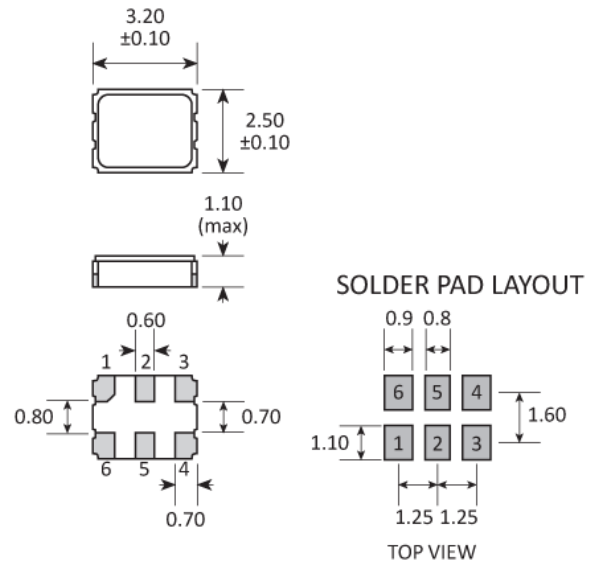

PAD	CONNECTION
1	Enable / disable
2	Not connected
3	Ground
4	Output 1 (Q)
5	Output 2 (Q̄)
6	Supply

Dimensions in mm

ORDERING INFORMATION

To request a quotation for the GXO-E31J please use the configurable options form to choose the options you require and then submit your configured product to our team. Our expert advisers are always happy to help with your requirements and can be contacted on +44 1460 256 100 or at sales@golledge.com.

Following product selection you will be issued with a seven character Golledge part number. Your Golledge part number is the internationally accepted Golledge manufacturing part number (MPN) that should be used for all project documentation, including bills of materials (BoMs) and purchase orders.

If you have any queries regarding any of our documentation our dedicated sales team will be happy to help.

ENABLE / DISABLE FUNCTION

Input (pad 1*)	Output 1 (pad 4)	Output 2 (pad 5)
Open	Enabled	Enabled
'1' level (≥0.7 V _{DD})	Enabled	Enabled
'0' level (≤0.3 V _{DD})	High Impedance	High Impedance

*Enable / Disable function can be on pad 2 on request.

MARKING

FREQUENCY DC
 • PARTNO

- Pin 1
- Marking type: Laser

DC = Date Code in YM, eg. "GF" = Jun 2017

	A	B	C	D	E	F	G	H	J	K	L	M
Y	1	2	3	4	5	6	7	8	9	0		
M	Jan	Feb	Mar	Apr	May	Jun	Jul	Aug	Sep	Oct	Nov	Dec

SOLDERING PROFILE

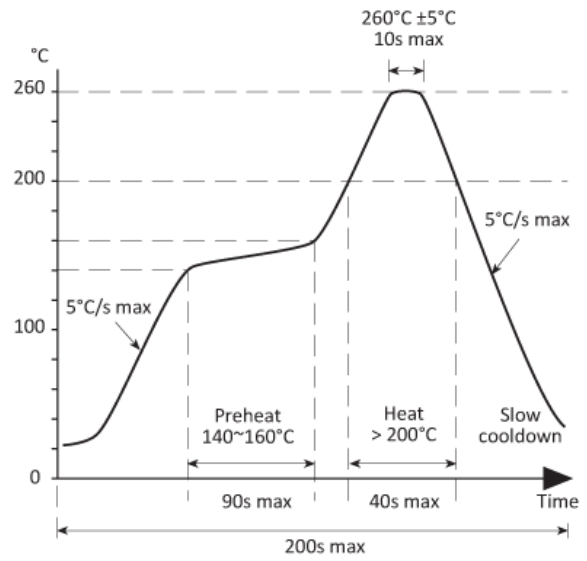

TAPE & REEL SPECIFICATION

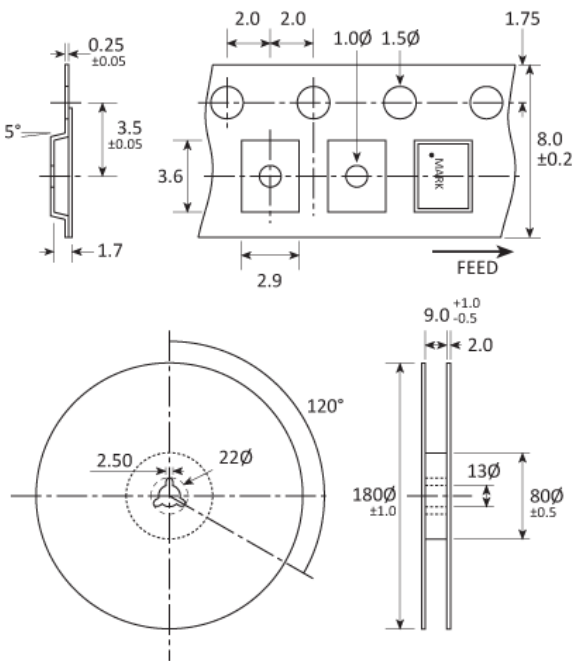

Dimensions in mm

HANDLING & STORAGE



Human Body Model (HBM) 1A (250V to <500V)





Moisture Sensitivity Level (MSL): 1 (or not applicable)

CONSTRUCTION

Ceramic body with gold-plated pads
Metal lid, seam sealed

COMPLIANCE

 Lead-free (< 0.1% by weight)

 RoHS compliant with no exemptions. [See our declaration](#)

 REACH compliant. [See our statement](#)

 Free of conflict minerals. [See our declaration](#)

 Free of Halogens. [See our declaration](#)

 Free of Ozone-depleting substances. [See our declaration](#)