

GXO-5304S

5.0V SM Oscillator

- Competitive pricing for high volumes
- Industry standard footprint
- Miniature ceramic package with metal lid
- Enable / disable tristate function

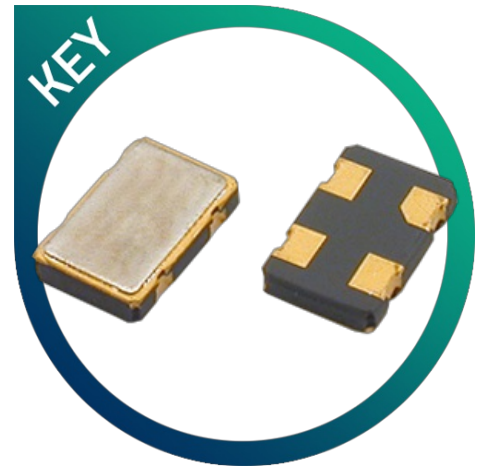

CONFIGURABLE OPTIONS

Parameter	Option Code
Frequency	
Frequency stability	
* see note below	
Any	
±100ppm max	
±50ppm max	B
±25ppm max	A
Operating temperature range	
Any	
-20 to +70 °C	
-40 to +85 °C	I
-40 to +125 °C	H

SPECIFICATIONS

Frequency range	0.625 ~ 160.0MHz
Dimensions	5.0 x 3.2 x 1.35mm
Storage temperature range	-55 to +125 °C
Supply voltage (V_{DD})	+5.0V ($\pm 10\%$)
Supply current	23mA max (≤ 16.0 MHz) 35mA max ($> 17.0 \sim 80.0$ MHz) 55mA max ($> 81.0 \sim 160.0$ MHz)
Logic levels	'0' level = 10% V_{DD} max '1' level = 90% V_{DD} min
Start up time	10ms max
Waveform symmetry	45:55 @ 50% V_{DD}
Driving ability	15pF CMOS
Rise / fall time	5ns max
Enable / disable function	Tristate (control via pad 1)
Ageing	± 5 ppm / year max

PACKAGE DRAWING

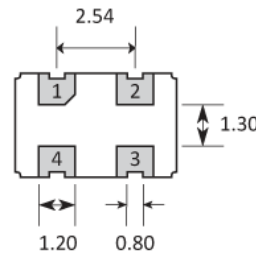
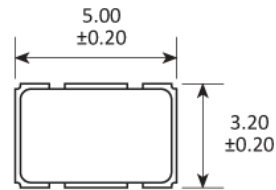

SOLDER PAD LAYOUT

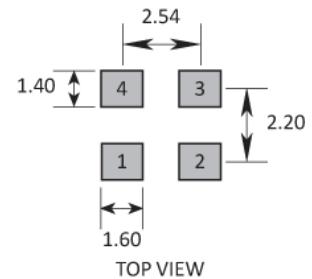

PAD	CONNECTION
1	Enable/Disable
2	Ground
3	Output
4	Supply

Dimensions in mm

ORDERING INFORMATION

To request a quotation for the GXO-5304S please use the configurable options form to choose the options you require and then submit your configured product to our team. Our expert advisers are always happy to help with your requirements and can be contacted on +44 1460 256 100 or at sales@golledge.com.

ENABLE / DISABLE FUNCTION

Input (pad 1)	Output (pad 3)
Open	Enabled
'1' level	Enabled
'0' level	High Impedance

MARKING

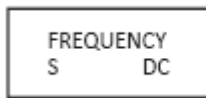

Marking type: Laser

DC = Date Code in YM, eg. "GF" = Jun 2017

	A	B	C	D	E	F	G	H	J	K	L	M
Y	1	2	3	4	5	6	7	8	9	0		
M	Jan	Feb	Mar	Apr	May	Jun	Jul	Aug	Sep	Oct	Nov	Dec

SOLDERING PROFILE

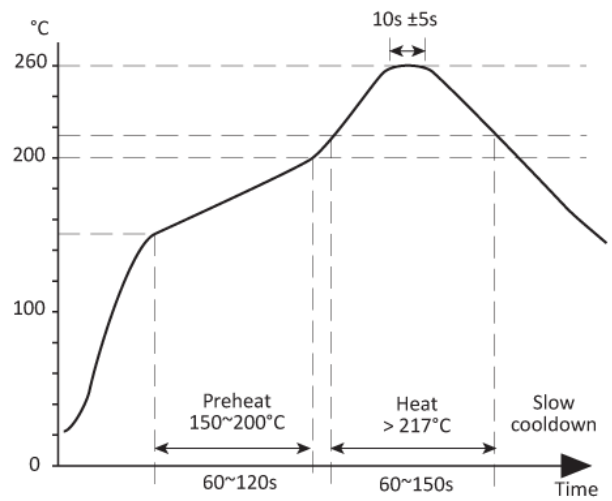

Lead free solderability limits: 260°C ±5°C x 10s ±5s x 2.

TAPE & REEL SPECIFICATION

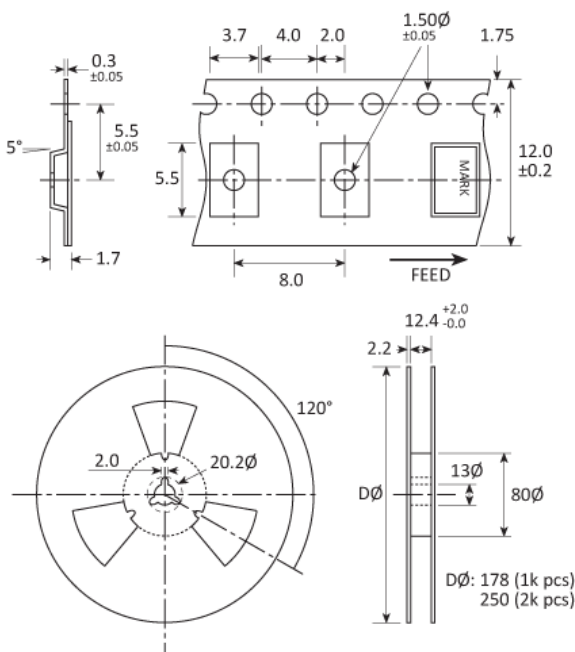

Dimensions in mm

HANDLING & STORAGE



Human Body Model (HBM) 1A (250V to <500V)





Moisture Sensitivity Level (MSL): 1 (or not applicable)

CONSTRUCTION

Ceramic body with gold-plated pads Metal lid, seam sealed

COMPLIANCE

 Lead-free (< 0.1% by weight)

 RoHS compliant with no exemptions. [See our declaration](#)

 REACH compliant. [See our statement](#)

 Free of conflict minerals. [See our declaration](#)

 Free of Halogens. [See our declaration](#)

 Free of Ozone-depleting substances. [See our declaration](#)

 Nominal Net Mass: