

GXO-3232L

3.3V Tight Stability Oscillator with 2520 Package

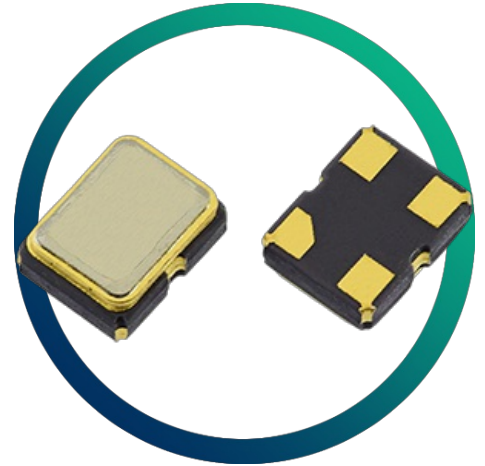

- High stability for WiMAX, LAN etc
- Low current consumption
- Miniature ceramic package with metal lid
- Enable / disable tristate function
- Competitive pricing

CONFIGURABLE OPTIONS

Parameter	Option Code
Frequency	
Frequency stability * see note below	
Any	
±15ppm max	E
±10ppm max	F

* Frequency stability is inclusive of calibration @ 25°C, operating temperature range, supply voltage change, load change, reflow and ageing

SPECIFICATIONS

Frequency range	4.0 ~ 54.0MHz
Dimensions	2.5 x 2.0 x 0.95mm
Operating temperature range	-40 to +85 °C
Storage temperature range	-40 to +85 °C
Supply voltage (V _{DD})	+3.3V (±10%)
Supply current	7mA max
Logic levels	'0' level = 10%V _{DD} max '1' level = 90%V _{DD} min
Start up time	0.2ms typ
Waveform symmetry	45:55 max @ 50%V _{DD}
Driving ability	15pF CMOS
Rise / fall time	5ns max
Enable / disable function	Tristate (control via pad 1) (E/D times 100µs / 100µs typ)
Stand-by current	10µA max
Period jitter RMS	3ps typ
Phase jitter RMS	0.09ps typ, 12kHz~10MHz
Phase noise	-140dBc/Hz typ @ 10kHz

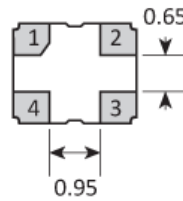
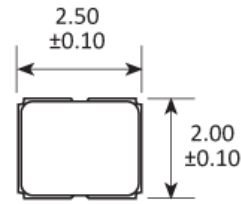
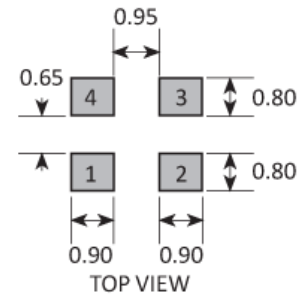
PACKAGE DRAWING

SOLDER PAD LAYOUT

PAD	CONNECTION
1	Enable/Disable
2	Ground
3	Output
4	Supply

Dimensions in mm

ORDERING INFORMATION

To request a quotation for the GXO-3232L please use the configurable options form to choose the options you require and then submit your configured product to our team. Our expert advisers are always happy to help with your requirements and can be contacted on +44 1460 256 100 or at sales@golledge.com.

Following product selection you will be issued with a seven character Golledge part number. Your Golledge part number is the internationally accepted Golledge manufacturing part number (MPN) that should be used for all project documentation, including bills of materials (BoMs) and purchase orders.

If you have any queries regarding any of our documentation our dedicated sales team will be happy to help.

ENABLE / DISABLE FUNCTION

Input (pad 1)	Output (pad 3)
Open	Enabled
'1' level	Enabled
'0' level	High Impedance

MARKING

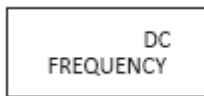

Marking type: Laser

DC = Date Code in YM, eg. "GF" = Jun 2017

	A	B	C	D	E	F	G	H	J	K	L	M
Y	1	2	3	4	5	6	7	8	9	0		
M	Jan	Feb	Mar	Apr	May	Jun	Jul	Aug	Sep	Oct	Nov	Dec

SOLDERING PROFILE

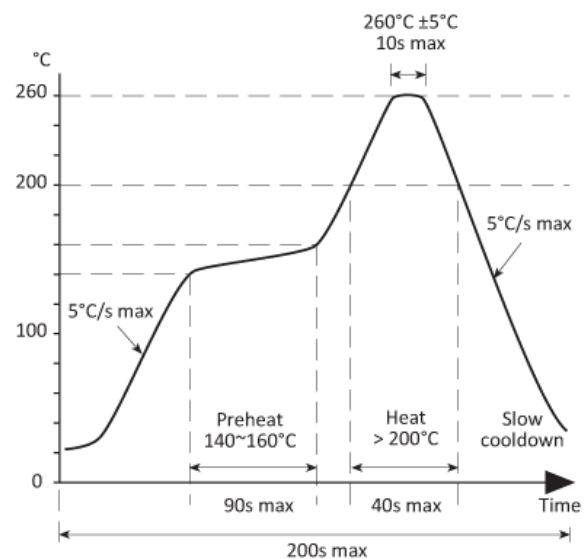

TAPE & REEL SPECIFICATION

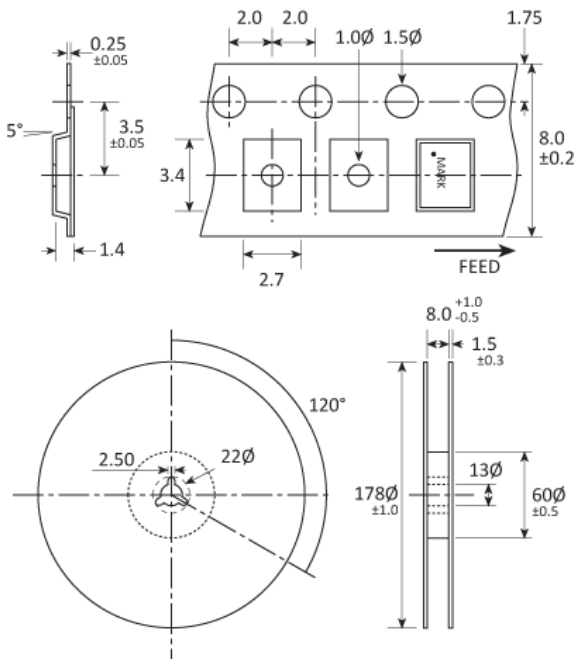

Dimensions in mm

CONSTRUCTION

Ceramic body with gold-plated pads
Metal lid, seam sealed

HANDLING & STORAGE



Human Body Model (HBM) 1A (250V to <500V)



Moisture Sensitivity Level (MSL): 1 (or not applicable)

COMPLIANCE



Lead-free (< 0.1% by weight)



RoHS compliant with no exemptions. [See our declaration](#)



REACH compliant. [See our statement](#)



Free of conflict minerals. [See our declaration](#)



Free of Halogens. [See our declaration](#)



Free of Ozone-depleting substances. [See our declaration](#)