

GTXO-C75K

2.8V SM Low Jitter TCXO with CMOS

Output

- 2.8V supply voltage
- Low power consumption
- Enable / disable tristate function
- Low phase noise and jitter
- Excellent frequency stability

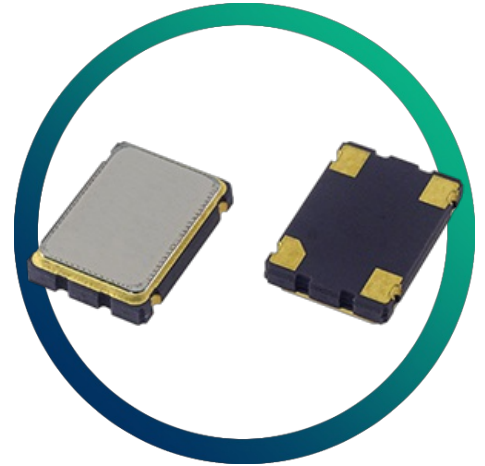

CONFIGURABLE OPTIONS

Parameter	Option Code
Frequency	
Temperature stability	
Any	
±3.0ppm max	K
±2.5ppm max	J
Temperature range	
Any	
0 to +50°C	R
-10 to +60°C	C
-20 to +70°C	N
-30 to +75°C	S
-40 to +85°C	I

SPECIFICATIONS

Frequency range	4.0 ~ 54.0MHz
Dimensions	7.0 x 5.0 x 1.5mm
Calibration tolerance	$\pm 2.0\text{ppm}$ @ $+25^\circ\text{C}$ $\pm 3^\circ\text{C}$ 60mins after reflow
Storage temperature range	-40 to $+125^\circ\text{C}$
Ageing	$\pm 1.0\text{ppm}$ max first year
Supply voltage (V_{DD})	$+2.8\text{V}$ ($\pm 5\%$)
Supply current	3.4 mA max, 4.0 ~ 10.0MHz 4.1mA max, $>10.0 \sim 20.0\text{MHz}$ 4.7mA max, $>20.0 \sim 30.0\text{MHz}$ 5.2mA max, $>30.0 \sim 40.0\text{MHz}$ 6.0mA max, $>40.0 \sim 54.0\text{MHz}$
Frequency vs supply voltage	$\pm 0.2\text{ppm}$, $V_{DD} \pm 5\%$
Driving ability	15pF CMOS
Logic levels	'0' level = $10\%V_{DD}$ max '1' level = $90\%V_{DD}$ min
Waveform symmetry	45:55 @ $50\%V_{DD}$
Rise / fall time	5ns max
Frequency vs load	$\pm 0.2\text{ppm}$, $Z_L \pm 10\%$
Enable / disable function	Tristate (control via pad 1)
Standby current	10 μA max
Phase noise (typ)	-145dBc/Hz @ 10kHz
Period jitter RMS	3ps typ

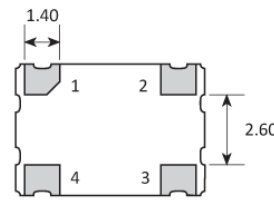
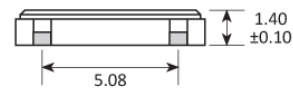
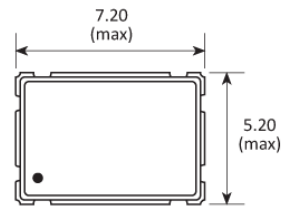
PACKAGE DRAWING

PAD	CONNECTION
1	Enable/Disable
2	Ground
3	Output
4	Supply

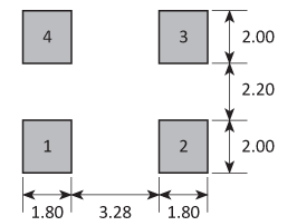

TOP VIEW

Dimensions in mm

ORDERING INFORMATION

To request a quotation for the GTXO-C75K please use the configurable options form to choose the options you require and then submit your configured product to our team. Our expert advisers are always happy to help with your requirements and can be contacted on +44 1460 256 100 or at sales@golledge.com.

Following product selection you will be issued with a seven character Golledge part number. Your Golledge part number is the internationally accepted Golledge manufacturing part number (MPN) that should be used for all project documentation, including bills of materials (BoMs) and purchase orders.

If you have any queries regarding any of our documentation our dedicated sales team will be happy to help.

ENABLE / DISABLE FUNCTION

Input (pad 1)	Output (pad 3)
Open	Enabled
'1' level	Enabled
'0' level	High Impedance

MARKING

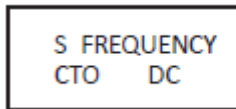

Marking type: Laser

DC = Date Code in YM, eg. "GF" = Jun 2017

	A	B	C	D	E	F	G	H	J	K	L	M
Y	1	2	3	4	5	6	7	8	9	0		
M	Jan	Feb	Mar	Apr	May	Jun	Jul	Aug	Sep	Oct	Nov	Dec

SOLDERING PROFILE

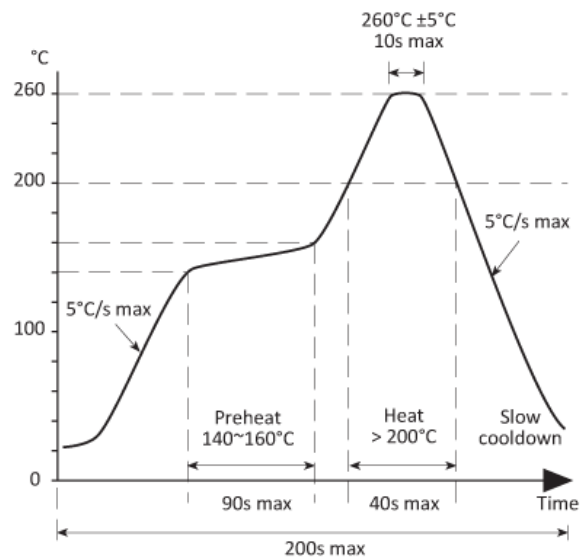

TAPE & REEL SPECIFICATION

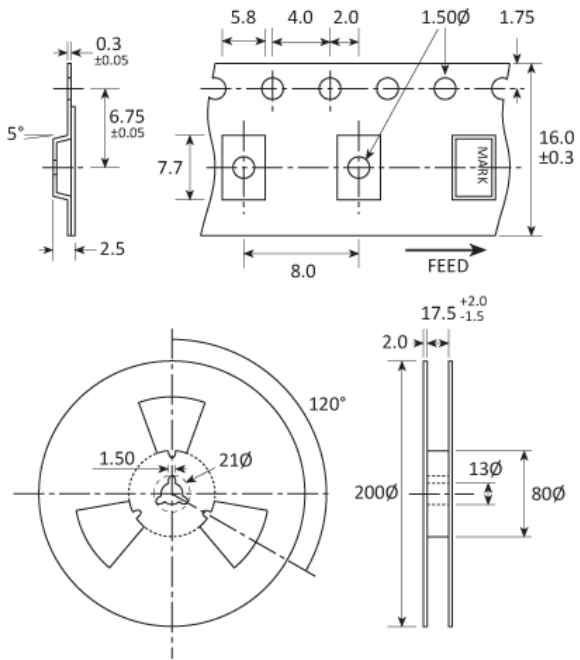

Dimensions in mm

CONSTRUCTION

Ceramic body with gold-plated pads
Metal lid, seam sealed

HANDLING & STORAGE



Human Body Model (HBM) 1A (250V to <500V)



Moisture Sensitivity Level (MSL): 1 (or not applicable)

COMPLIANCE



Lead-free (< 0.1% by weight)



RoHS compliant with no exemptions. [See our declaration](#)



REACH compliant. [See our statement](#)



Free of conflict minerals. [See our declaration](#)



Free of Halogens. [See our declaration](#)



Free of Ozone-depleting substances. [See our declaration](#)