

GTXO-251V

1.8V ~ 3.3V Ultra-tight Stability

VCTCXO for AIS

- Ideally suited for AIS and GPS applications
- $\pm 0.5\text{ppm}$ frequency stability option
- Wide frequency pullability options
- Ultra-miniature 2520 SM package

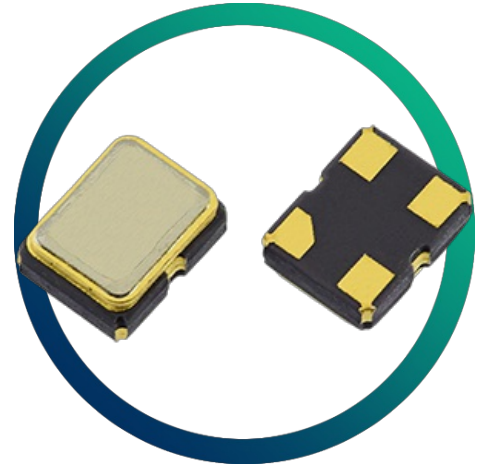

CONFIGURABLE OPTIONS

Parameter	Option Code
Frequency	
Frequency stability	
Any	
$\pm 2.0\text{ppm}$	
$\pm 0.5\text{ppm}$	
Temperature range	
Any	
-20 to $+75^\circ\text{C}$	
-40 to $+85^\circ\text{C}$	
Frequency adjustment	
$\pm 8 \sim \pm 14\text{ppm}$, $1.5\text{V} \pm 1.0\text{V}$	
$\pm 15 \sim \pm 25\text{ppm}$, $1.5\text{V} \pm 1.0\text{V}$	
Supply voltage (V_{DD})	
Operable from $1.8\text{V} \sim 3.3\text{V}$, please specify test voltage:	
3.3V	

SPECIFICATIONS

Frequency range	16.0 ~ 52.0MHz
Dimensions	2.5 x 2.0 x 0.8mm
Storage temperature range	-40 to +85°C
Supply voltage stability	±0.2ppm, V_{DD} ±5%
Load stability	±0.2ppm, Z_L ±10%
Frequency slope	±0.05ppm/°C over -30+85°C
Ageing	±1.0ppm max first year
Supply voltage (V_{DD})	Operable from 1.8V ~ 3.3V
Supply current	1.5mA max (up to 26MHz) 2.0mA max (26 ~ 32MHz) 2.5mA max (32 ~ 52MHz)
Output waveform	Clipped sine, 0.8V p-p
Test load (Z_L)	10kΩ // 10pF
Start up time	3ms max
Harmonics	-5dBc max
Phase noise	-135dBc/Hz @ 1kHz
Frequency tolerance @ 25°C	±2.0ppm max, 60mins after reflow

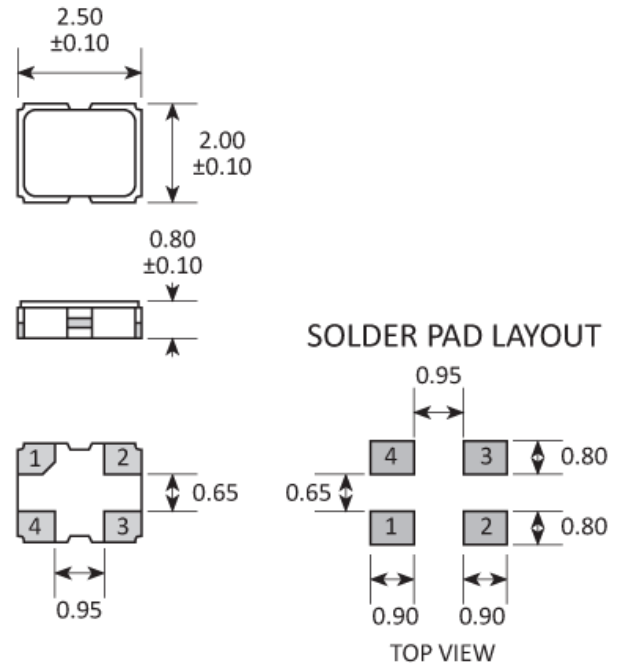
PACKAGE DRAWING

PAD	CONNECTION
1	Freq adjustment
2	Ground
3	Output
4	Supply

Dimensions in mm

ORDERING INFORMATION

To request a quotation for the GTXO-251V please use the configurable options form to choose the options you require and then submit your configured product to our team. Our expert advisers are always happy to help with your requirements and can be contacted on +44 1460 256 100 or at sales@golledge.com.

Following product selection you will be issued with a seven character Golledge part number. Your Golledge part number is the internationally accepted Golledge manufacturing part number (MPN) that should be used for all project documentation, including bills of materials (BoMs) and purchase orders.

If you have any queries regarding any of our documentation our dedicated sales team will be happy to help.

SOLDERING PROFILE

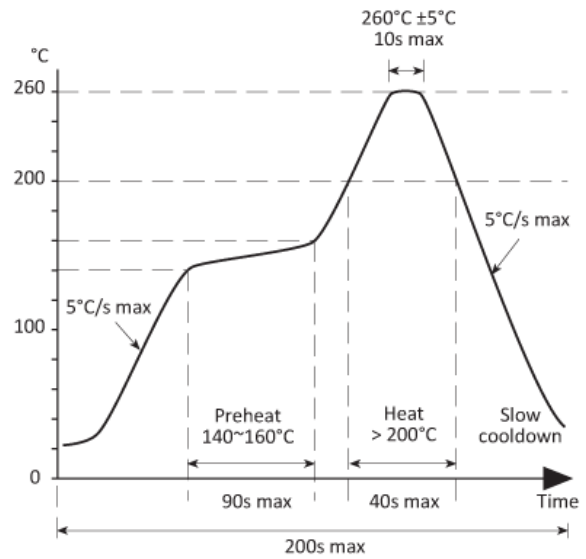

TAPE & REEL SPECIFICATION

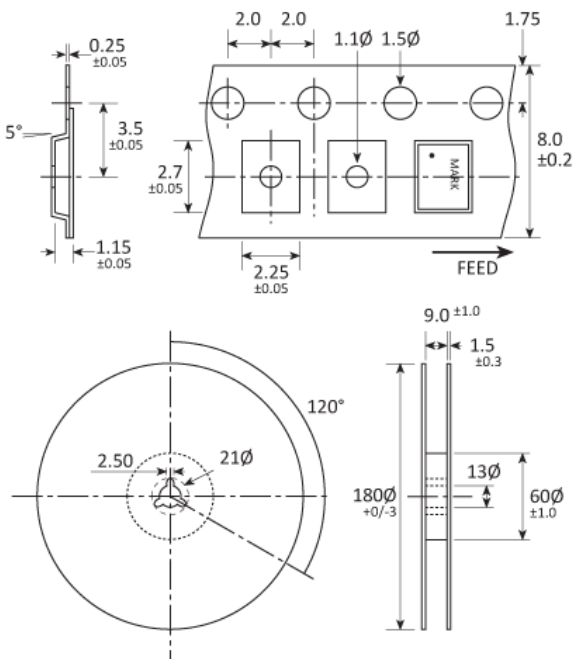

Dimensions in mm

HANDLING & STORAGE



Human Body Model (HBM) 1A (250V to <500V)





Moisture Sensitivity Level (MSL): 1 (or not applicable)

CONSTRUCTION

Ceramic body with gold-plated pads
Metal lid, seam sealed

COMPLIANCE

 Lead-free (< 0.1% by weight)

 RoHS compliant with no exemptions. [See our declaration](#)

 REACH compliant. [See our statement](#)

 Free of conflict minerals. [See our declaration](#)

 Free of Halogens. [See our declaration](#)

 Free of Ozone-depleting substances. [See our declaration](#)