

GSF-71 21S7B

21.4MHz 4 pole crystal filter with 7.5kHz 3dB bandwidth

- 45.0MHz and other frequencies up to 70MHz available
- Custom specifications available
- Miniature SM package

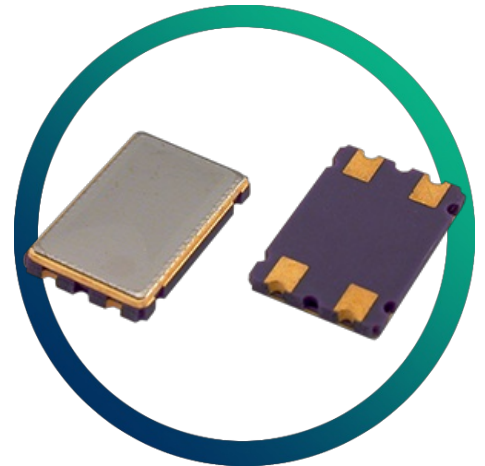

CONFIGURABLE OPTIONS

Parameter

Option Code

The GSF-71 21S7B has no configurable options.

Please see the specifications table for more details or contact our team today if you have other specification requirements.

SPECIFICATIONS

Centre frequency	21.4MHz
Dimensions	7.5 x 5.2 x 1.1mm
Operating temperature range	-20 to +60°C
Number of poles	4
Pass band	-3dB @ ±3.75kHz min
Attenuation band	-35dB @ ±14.0kHz max
In-band ripple	1.0dB max
Insertion loss	2.5dB max
Guaranteed attenuation	-80dB max -910 ±10kHz
Termination	850Ω // 3.5pF
Coupling capacitance (C _c)	15.0pF
Number of units	2

ORDERING INFORMATION

To request a quotation for the GSF-71 21S7B please use the configurable options form to choose the options you require and then submit your configured product to our team. Our expert advisers are always happy to help with your requirements and can be contacted on +44 1460 256 100 or at sales@golledge.com.

Following product selection you will be issued with a seven character Golledge part number. Your Golledge part number is the internationally accepted Golledge manufacturing part number (MPN) that should be used for all project documentation, including bills of materials (BoMs) and purchase orders.

If you have any queries regarding any of our documentation our dedicated sales team will be happy to help.

SOLDERING PROFILE

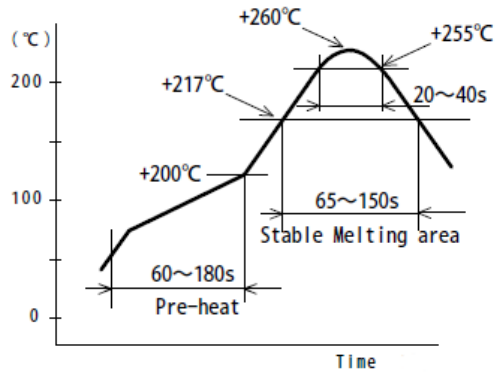

TAPE & REEL SPECIFICATION

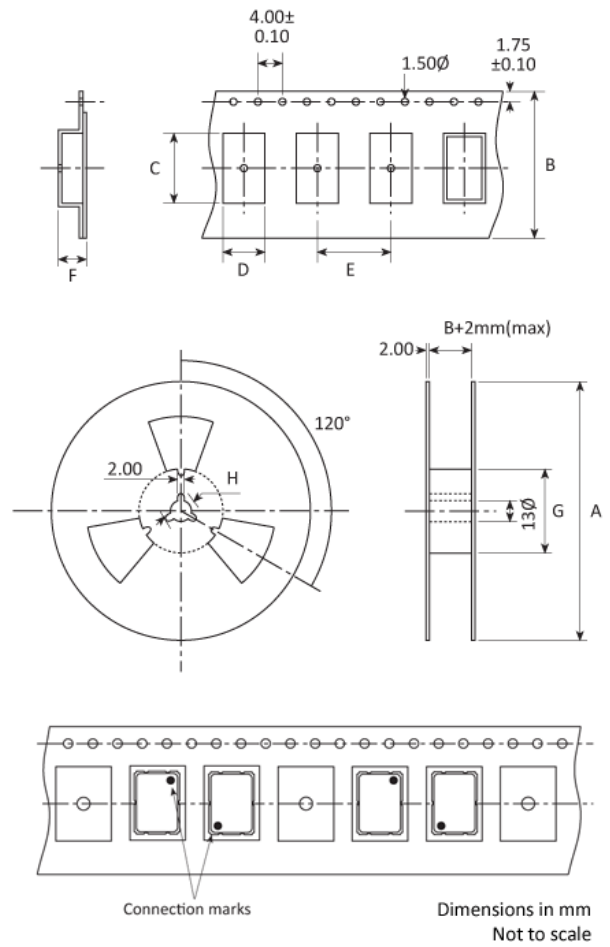

A:250 B:17.5 C:7.9 D:5.4 E:8 F:1.7 G:80 H:21

HANDLING & STORAGE



Human Body Model (HBM) 1A (250V to <500V)



Moisture Sensitivity Level (MSL): 1 (or not applicable)

CONSTRUCTION

Ceramic base with metal lid

COMPLIANCE



Lead-free (< 0.1% by weight)



RoHS compliant with no exemptions. [See our](#)

[declaration](#)



REACH compliant. [See our statement](#)



Free of conflict minerals. [See our declaration](#)



Free of Halogens. [See our declaration](#)



Free of Ozone-depleting substances. [See our](#)

[declaration](#)