

GVXO-753D

3.3V 4-pad Cost Effective VCXO

- Low cost for volume applications
- Choice of pullability & stability

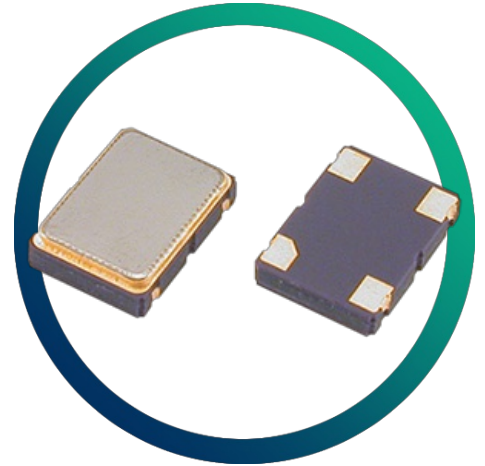

CONFIGURABLE OPTIONS

Parameter	Option Code
Frequency	
Frequency pullability	
Any	
±50ppm min	N
±100ppm min	S
±120ppm min	V
Frequency stability	
Any	
±50ppm max	B
±25ppm max	C
Operating temperature range	
Any	
-20 to +70 °C	
-40 to +85 °C	I

SPECIFICATIONS

Frequency range	1.50 ~ 54.0MHz
Dimensions	7.0 x 5.0 x 1.8mm
Package	4 pads, 5.08mm pitch
Voltage control	+1.65V ±1.50V, 10% linearity
Storage temperature range	-40 to +85 °C
Supply voltage (V _{DD})	+3.3V (±10%)
Supply current	10mA max (1.5 ~ 20.0MHz) 15mA max (>20.0 ~ 30.0MHz) 20mA max (>30.0 ~ 40.0MHz) 25mA max (>40.0MHz)
Driving ability	15pF CMOS
Logic levels	'0' level = 10%V _{DD} max '1' level = 90%V _{DD} min
Waveform symmetry	45:55 max
Rise / fall time (10%~90%V _{DD})	10ns max (1.5 ~ 10.0MHz) 6ns max (>10.0MHz)
Phase noise	-130dBc/Hz typ @ 1kHz
Net mass	150mg

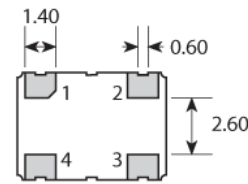
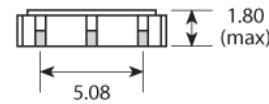
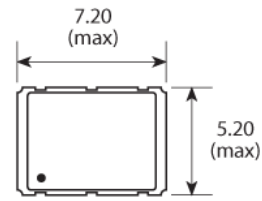
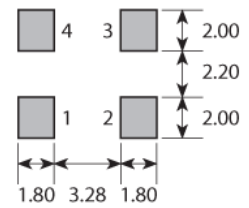
PACKAGE DRAWING

SOLDER PAD LAYOUT

TOP VIEW

PAD	CONNECTION
1	Control voltage
2	Ground
3	Output
4	Supply

Dimensions in mm

ORDERING INFORMATION

To request a quotation for the GVXO-753D please use the configurable options form to choose the options you require and then submit your configured product to our team. Our expert advisers are always happy to help with your requirements and can be contacted on +44 (0)1460 256 100 or at sales@golledge.com.

Once we've received your request our expert team will then produce a quotation tailored to meet your needs using the option codes you've selected.

Following product selection you will be issued with a seven character Golledge part number. Your Golledge part number is the internationally accepted Golledge manufacturing part number (MPN) that should be used for all project documentation, including bills of materials (BoMs) and purchase orders.

If you have any queries regarding any of our documentation our dedicated sales team will be happy to help.

ENABLE / DISABLE FUNCTION

Input (pad 2)	Output (pad 4)
Open	Enabled
'1' level	Enabled
'0' level	High Impedance

MARKING

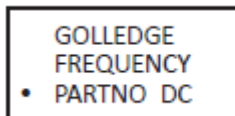

- Pin 1
- Marking type: Laser

DC = Date Code in YM, eg. "GF" = Jun 2017

	A	B	C	D	E	F	G	H	J	K	L	M
Y	1	2	3	4	5	6	7	8	9	0		
M	Jan	Feb	Mar	Apr	May	Jun	Jul	Aug	Sep	Oct	Nov	Dec

SOLDERING PROFILE

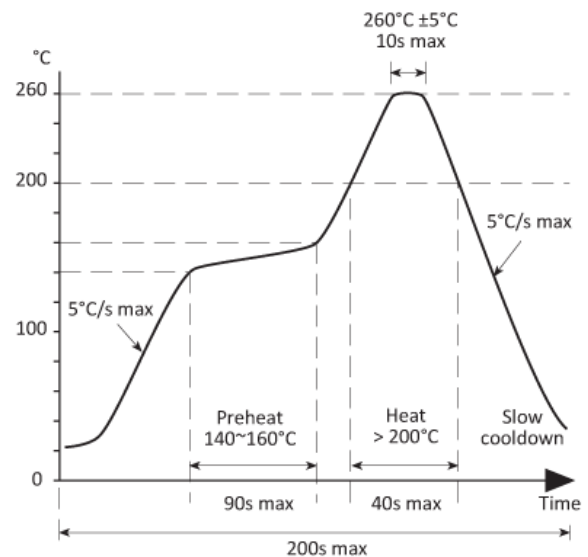

TAPE & REEL SPECIFICATION

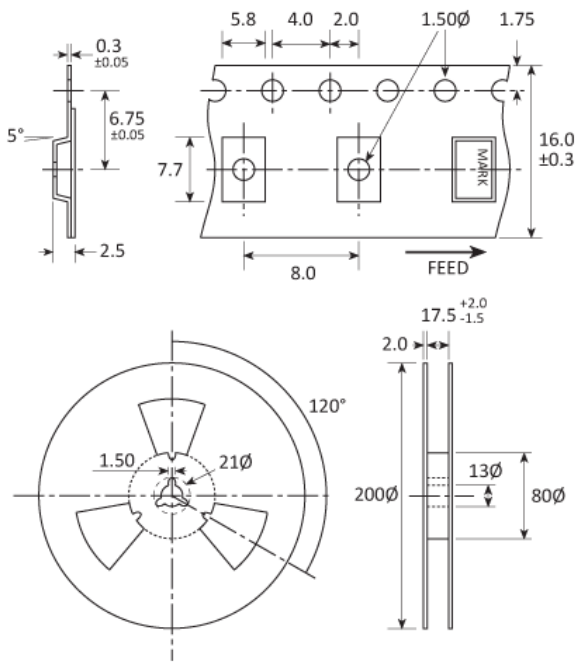

Dimensions in mm

CONSTRUCTION

Ceramic body with gold-plated pads Metal lid, seam sealed

HANDLING & STORAGE



Human Body Model (HBM) 1A (250V to <500V)



Moisture Sensitivity Level (MSL): 1 (or not applicable)

COMPLIANCE

Please refer to our **DOCUMENTS** section for more information.



Lead-free (< 0.1% by weight)



RoHS compliant with no exemptions.



REACH compliant.



Free of conflict minerals.



Free from halogens.



Free from ozone-depleting substances.